

G:B:D:

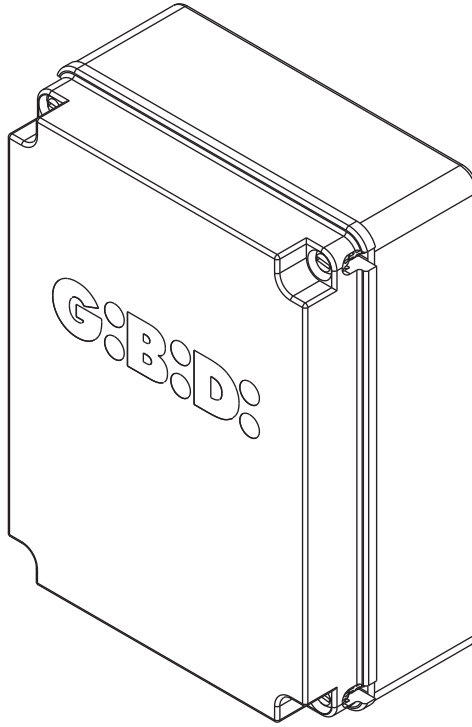

:SC

CE

SC380 (AS05800 - AS05810)

Apparecchiatura elettronica
SCHEMA ELETTRICO E COLLEGAMENTI

Electronic control unit
ELECTRICAL CONNECTIONS

I UK

I-UK**I**

- Questo prodotto è stato collaudato da Gi.Bi.Di., verificando la perfetta corrispondenza delle sue caratteristiche alle direttive vigenti.
- Gi.Bi.Di. S.r.l. si riserva la facoltà di modificare i dati tecnici senza alcun preavviso, in funzione dell'evoluzione del prodotto.

**LEGGERE ATTENTAMENTE QUESTO MANUALE PRIMA DI PROCEDERE ALL'INSTALLAZIONE.****UK**

- This product has been tested by Gi.Bi.Di. verifying the perfect correspondence of its characteristics to the current directive.
- Gi.Bi.Di. S.r.l. reserves the right to modify the technical data, without prior notice, depending on the product development.

**PLEASE READ CAREFULLY THIS MANUAL BEFORE PROCEEDING WITH THE INSTALLATION.**

I-UK

DIMENSIONI / DIMENSIONS

1

(AS05810)

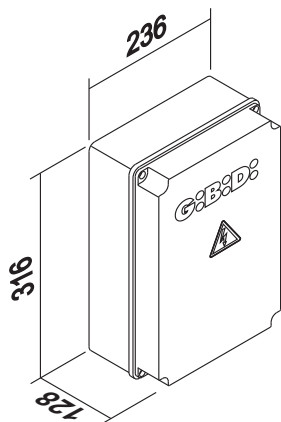

(AS05800)

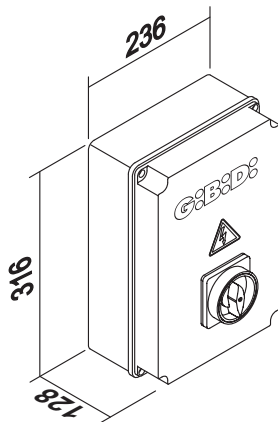

INSTALLAZIONE / INSTALLATION

2

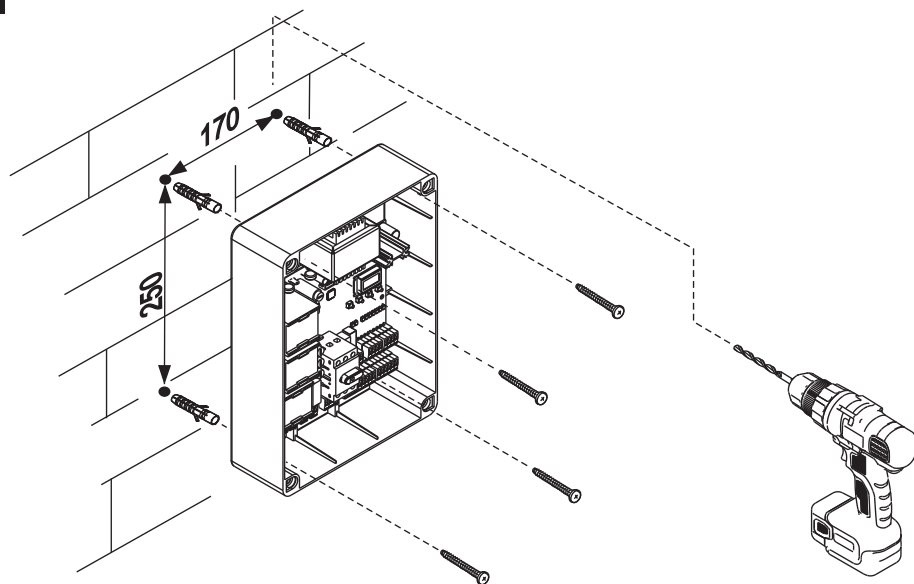

I-UK

SCHEMA ELETTRICO TRASFORMATORE / TRANSFORMER ELECTRICAL CONNECTIONS

3

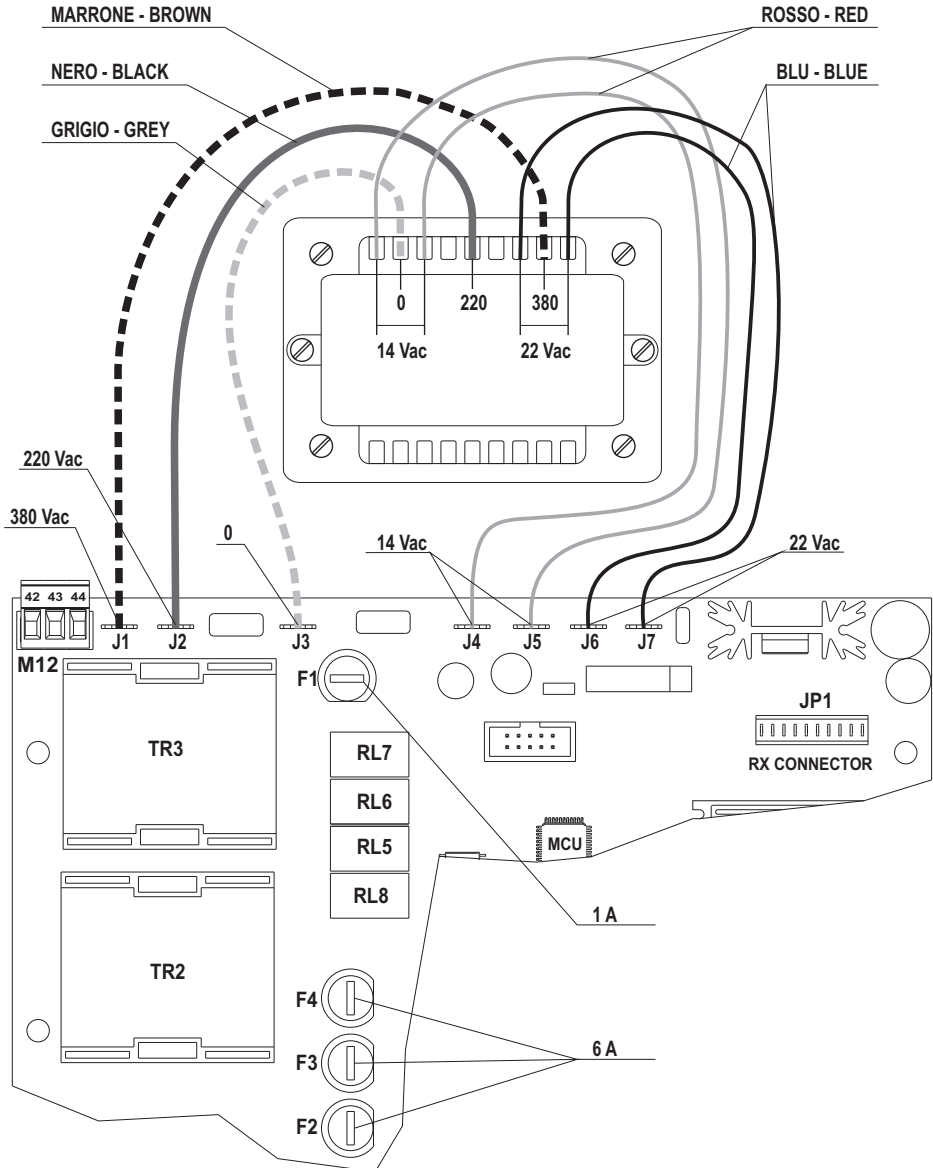

SCHEMA ELETTRICO (AS05810) / ELECTRICAL CONNECTIONS (AS05810)

4

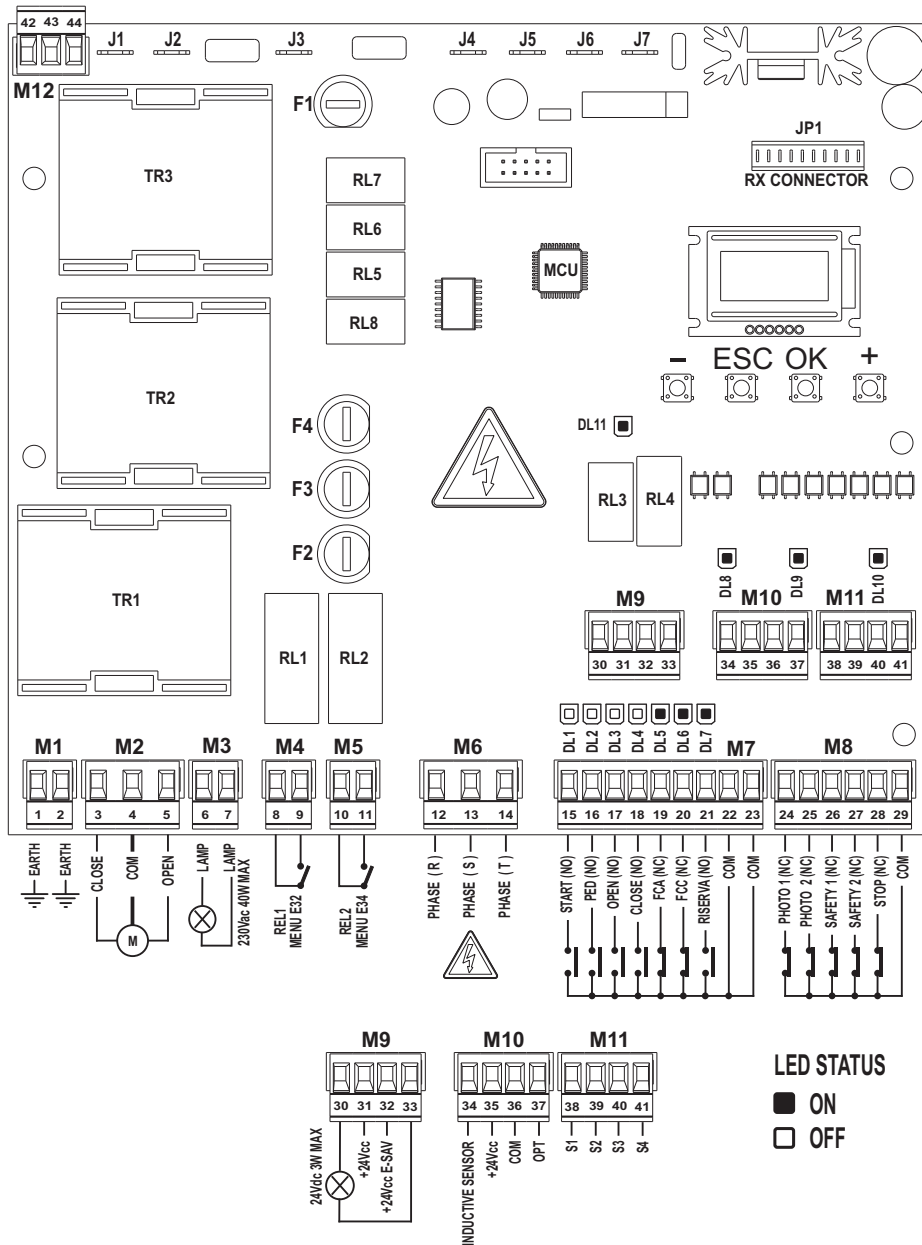

I-UK

SCHEMA ELETTRICO (AS05800) / ELECTRICAL CONNECTIONS (AS05800)

5

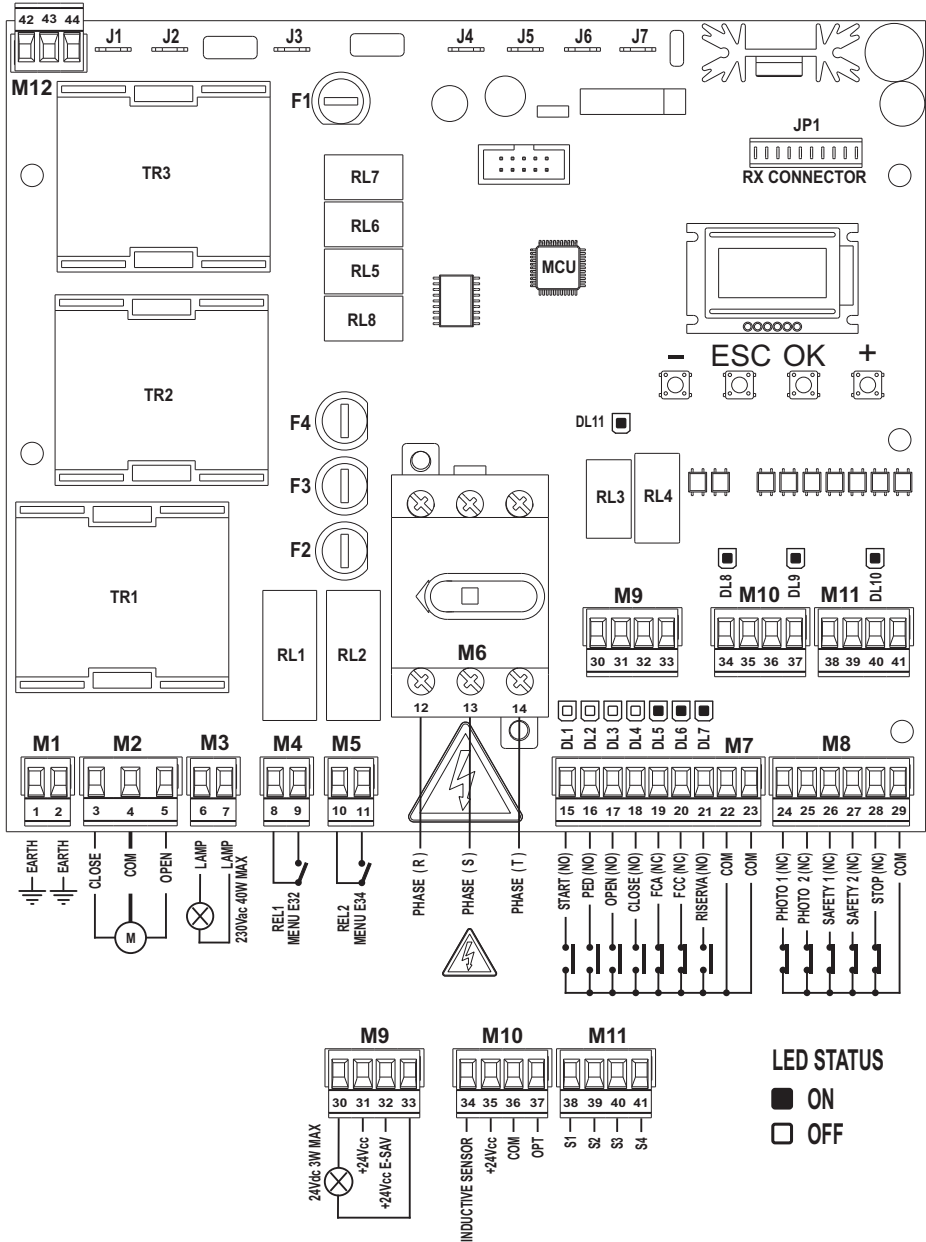

COLLEGAMENTO CON 380 Vac 3 FASI / 380 Vac 3 PHASES POWER SUPPLY

6

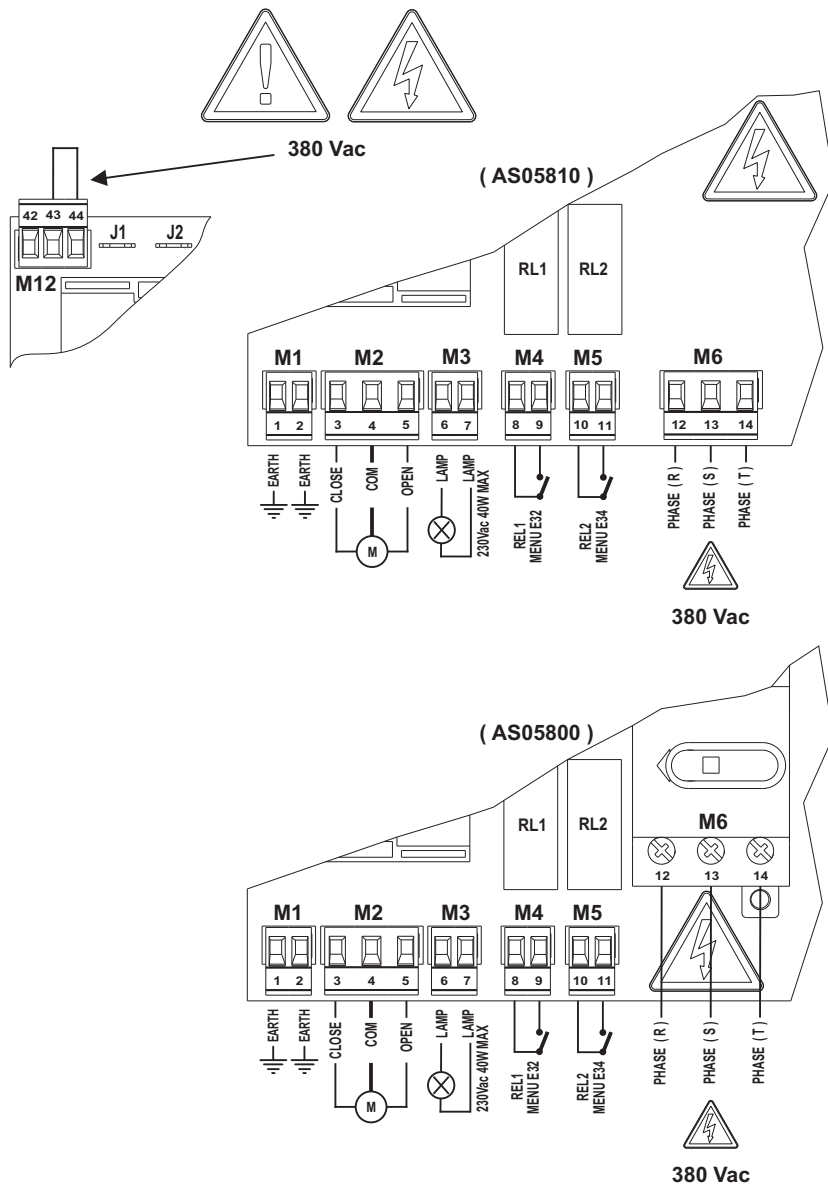

I-UK

COLLEGAMENTO CON 230 Vac 3 FASI / 230 Vac 3 PHASES POWER SUPPLY

7

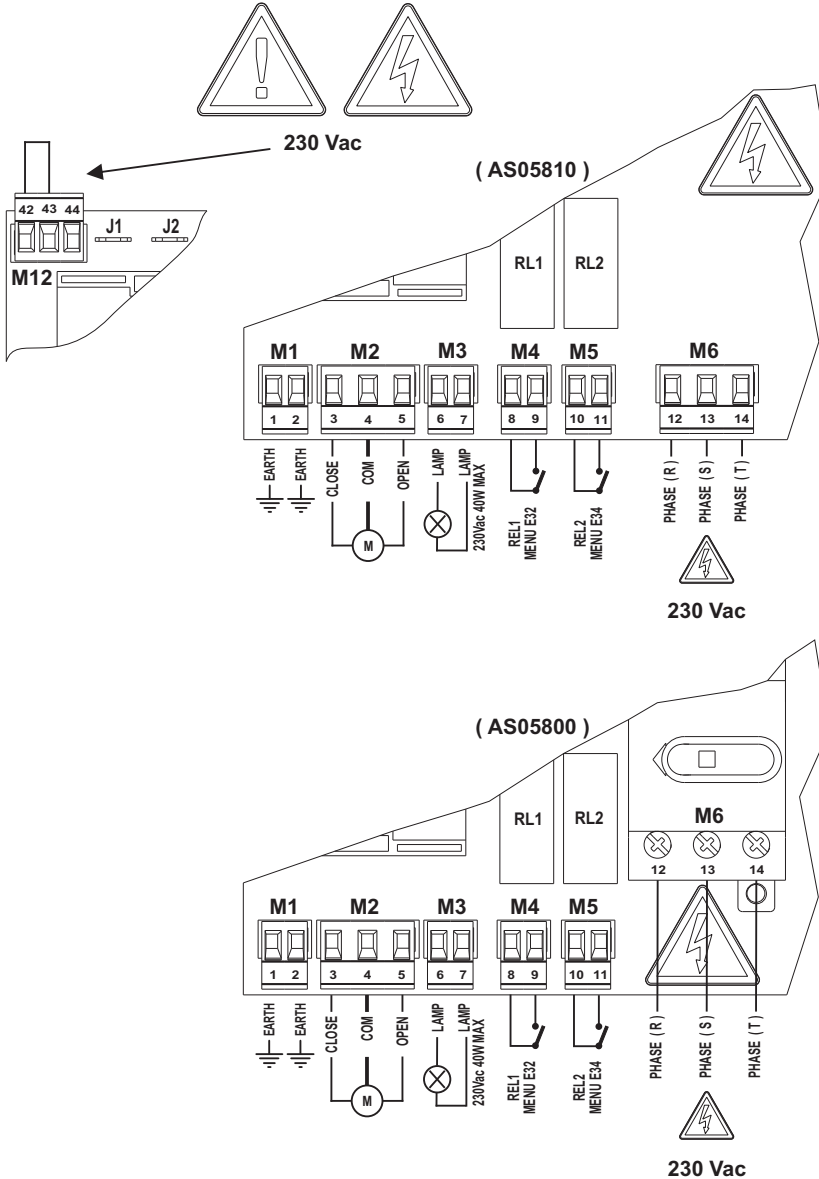

COLLEGAMENTO CON 230 Vac MONOFASE / 230 Vac 1 PHASE POWER SUPPLY

8

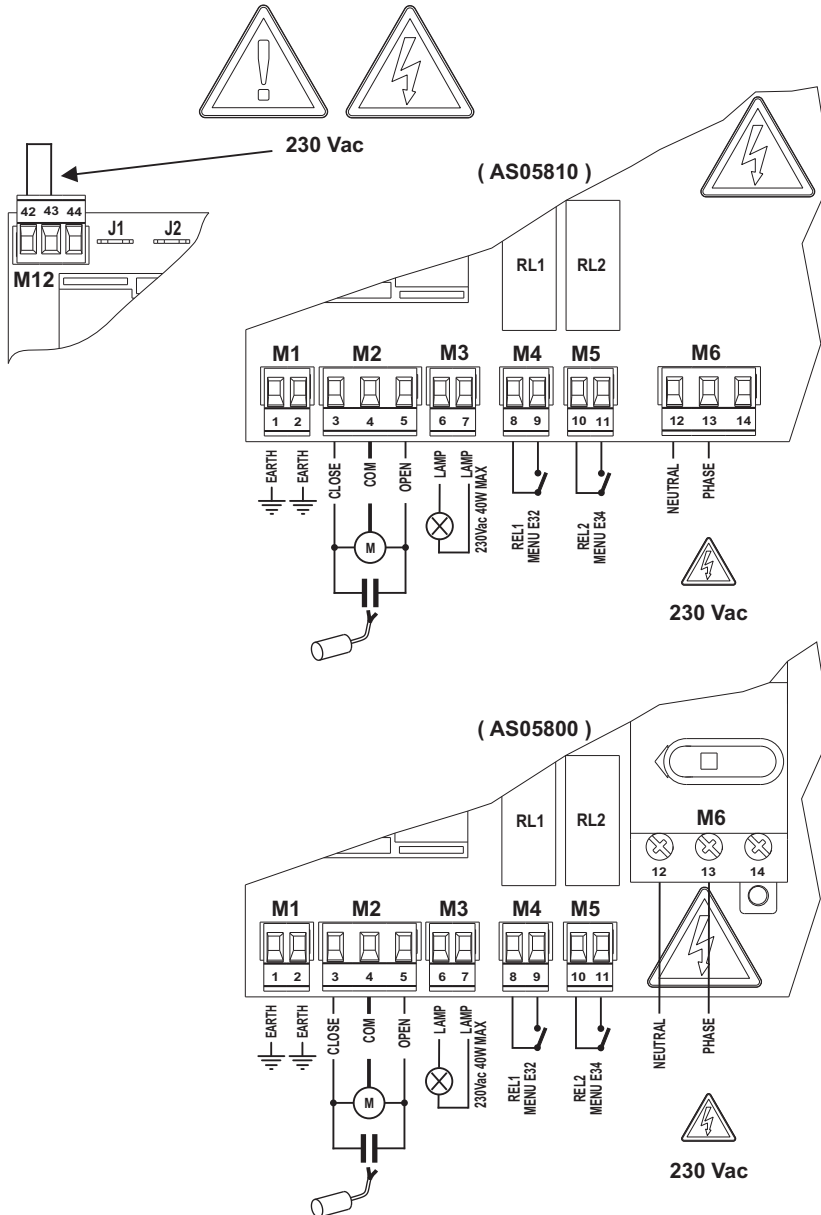

I-UK

COLLEGAMENTO DI TERRA / EARTH CONNECTION

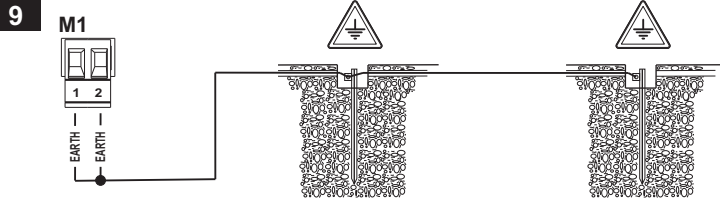

COLLEGAMENTO MOTORE 380 Vac 3 FASI / 380 Vac 3 PHASES MOTOR CONNECTION

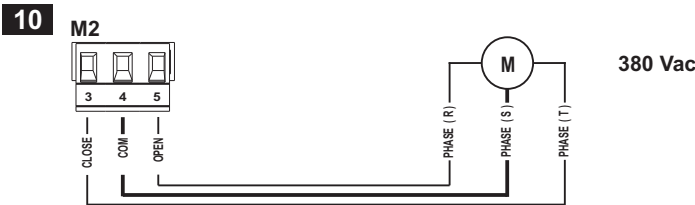

COLLEGAMENTO MOTORE 230 Vac 3 FASI / 230 Vac 3 PHASES MOTOR CONNECTION

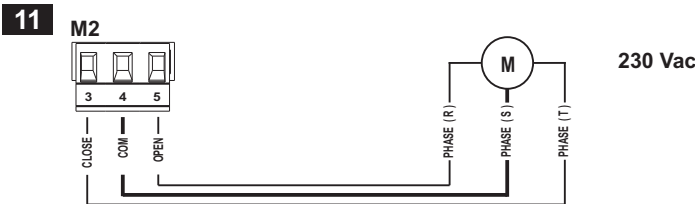

COLLEGAMENTO MOTORE 230 Vac MONOFASE / 230 Vac 1 PHASE MOTOR CONNECTION

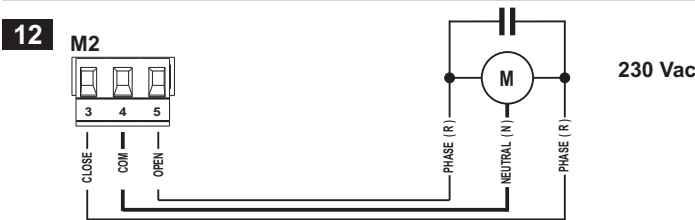

COLLEGAMENTO LAMPEGGIANTE / FLASHING LIGHT CONNECTION

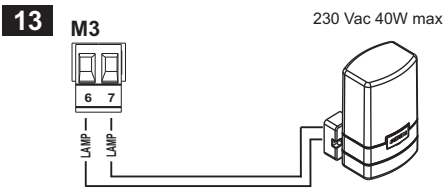

MENU - C 2	
Ref	
2	
3	

MORSETTO MULTIFUNZIONE M4 / M4 MULTIFUNCTION TERMINAL BLOCK

14

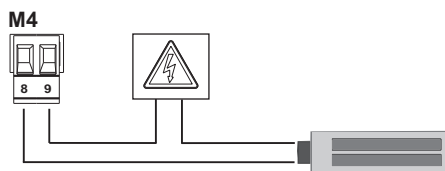
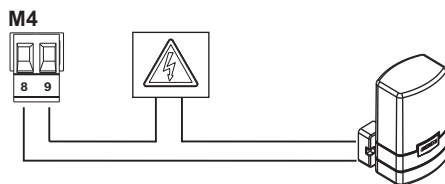
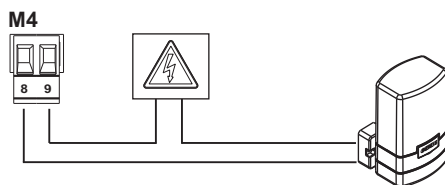
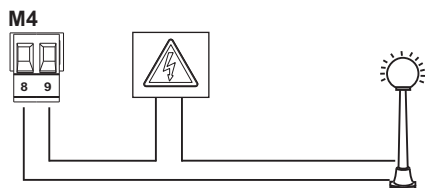
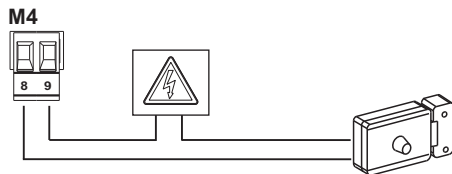

Rif	MENU - E 32	
2	<p>on off ... 3 sec ...</p>	<p>on off ... 3 sec ...</p>
3	<p>on off ... 3 Min ...</p>	<p>on off ... 3 Min ...</p>
4	<p>on off ...</p>	<p>on off ...</p>
5	<p>on off ...</p>	<p>on off ...</p>
6	<p>on off ... 3 sec ...</p>	<p>on off ... 3 sec ...</p>

I-UK

MORSETTO MULTIFUNZIONE M 5 / M5 MULTIFUNCTION TERMINAL BLOCK

15

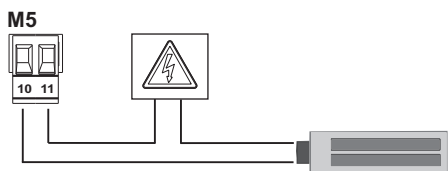
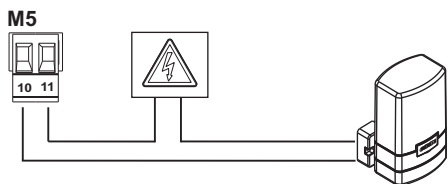
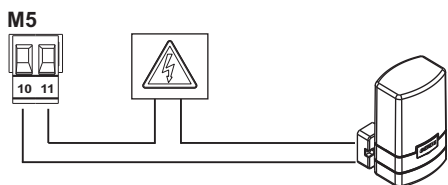
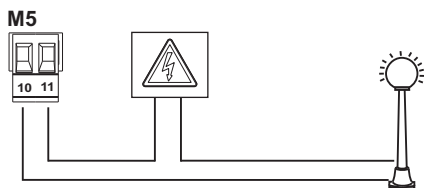
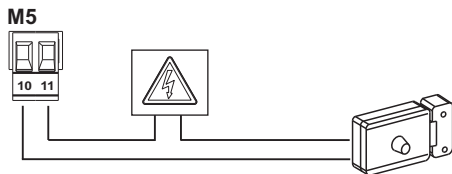

Rif	MENU - E 34	
2	<p>on off ... 3 sec</p>	<p>on off ... 3 sec</p>
3	<p>on off ... 3 Min</p>	<p>on off ... 3 Min</p>
4	<p>on off ...</p>	<p>on off ...</p>
5	<p>on off ...</p>	<p>on off ...</p>
6	<p>on off ... 3 sec</p>	<p>on off ... 3 sec</p>

I-UK

COLLEGAMENTO DISPOSITIVI DI COMANDO / CONTROL DEVICES CONNECTION

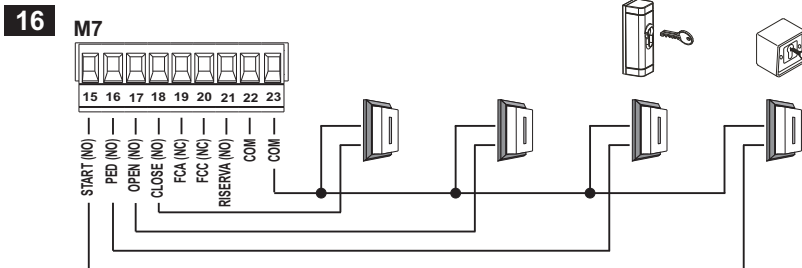

COLLEGAMENTO FINECORSA / LIMIT SWITCHES CONNECTION

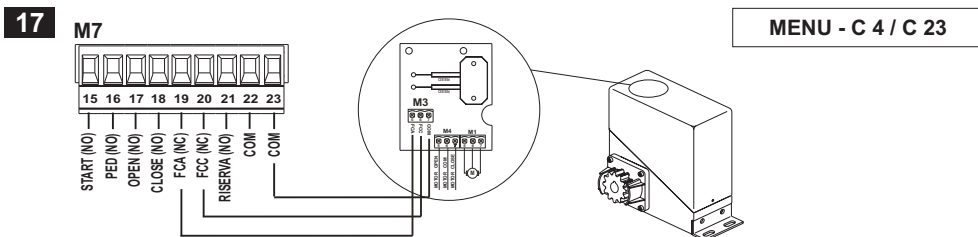

COLLEGAMENTO OROLOGIO / EXTERNAL CLOCK CONNECTION

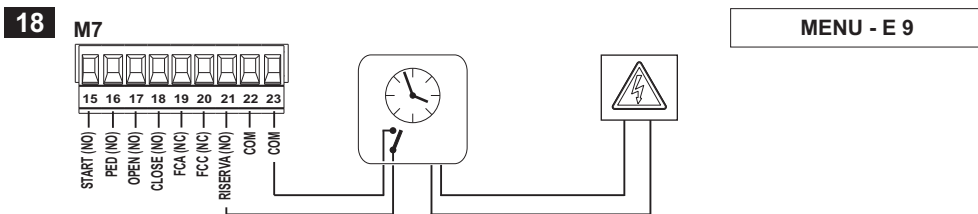

COLLEGAMENTO SPIRA MAGNETICA / ELECTROMAGNETIC DETECTOR CONNECTION

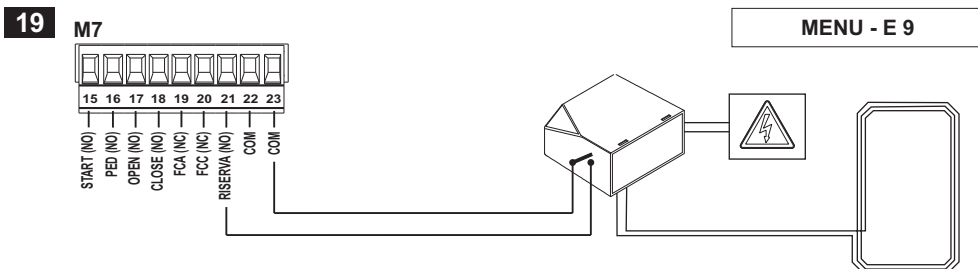

I-UK

COLLEGAMENTO FOTOCELLULE 1 / PHOTOCELLS 1 CONNECTION

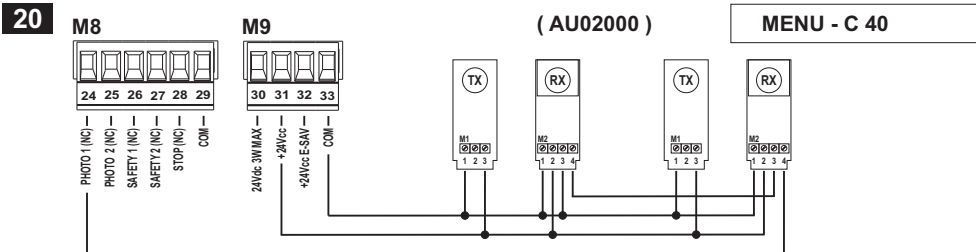

COLLEGAMENTO FOTOCELLULE 1 CON TEST / PHOTOCELLS 1 WITH TEST CONNECTION

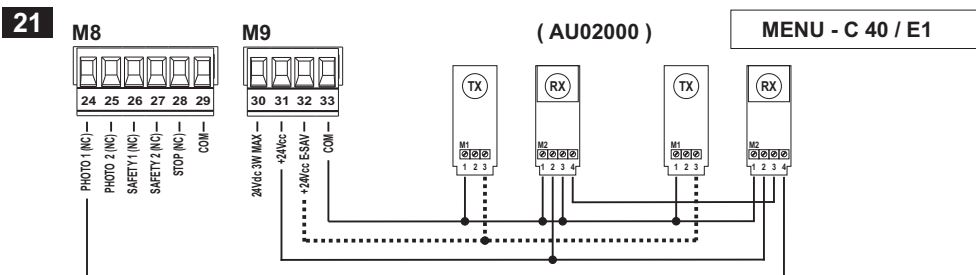

COLLEGAMENTO FOTOCELLULE 2 / PHOTOCELLS 2 CONNECTION

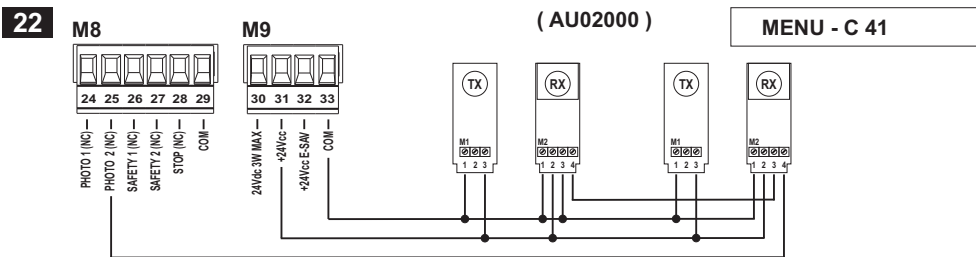

COLLEGAMENTO FOTOCELLULE 2 CON TEST / PHOTOCELLS 2 WITH TEST CONNECTION

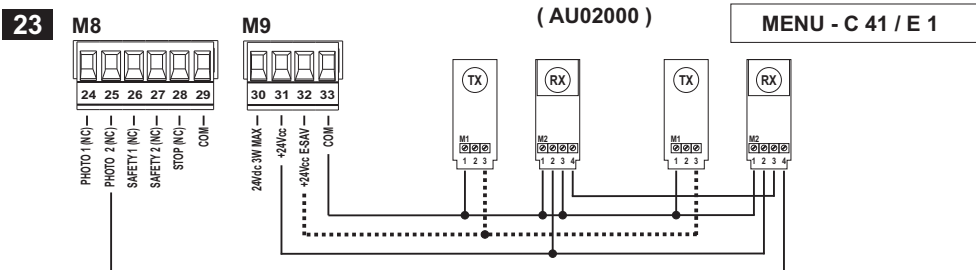

COLLEGAMENTO FOTOCELLULE 1 / PHOTOCELLS 1 CONNECTION

24

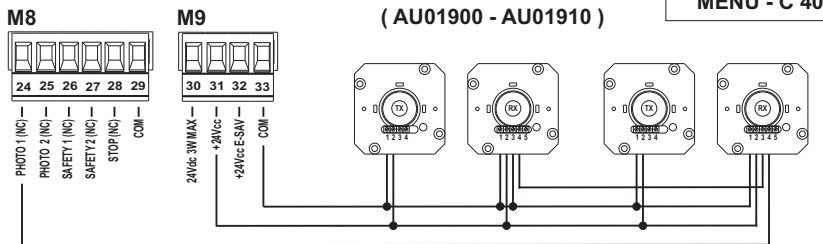

COLLEGAMENTO FOTOCELLULE 1 CON TEST / PHOTOCELLS 1 CONNECTION WITH TEST

25

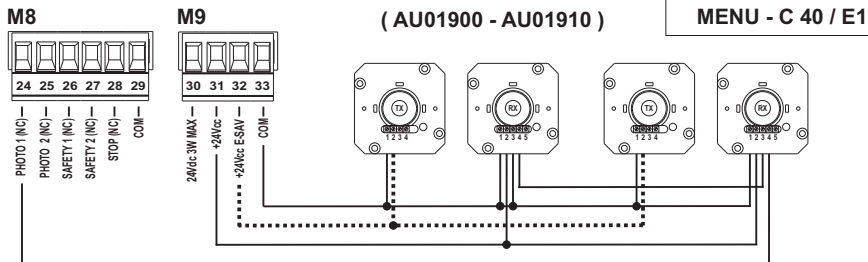

COLLEGAMENTO FOTOCELLULE 2 / PHOTOCELLS 2 CONNECTION

26

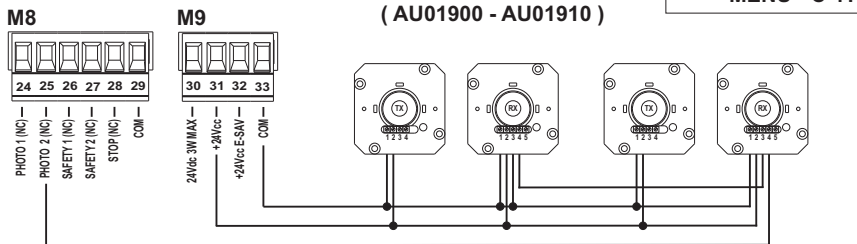

COLLEGAMENTO FOTOCELLULE 2 CON TEST / PHOTOCELLS 2 CONNECTION WITH TEST

27

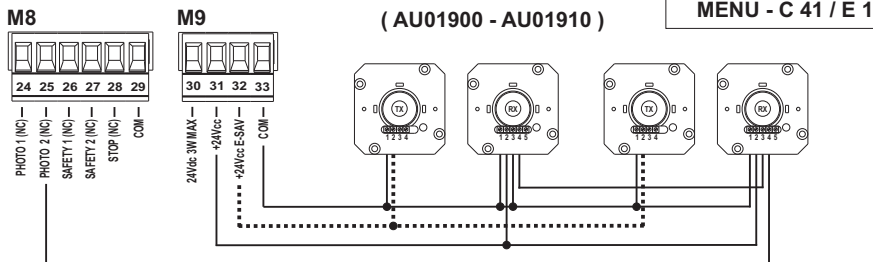

CONSULTARE IL MANUALE DELLE FOTOCELLULE PER MAGGIORI DETTAGLI / REFER TO THE PHOTOCELLS MANUAL FOR DETAILED CONNECTION DIAGRAMS

I-UK

COLLEGAMENTO "DISPOSITIVO DI SICUREZZA 1" NC / NC "SAFETY DEVICE 1" CONNECTION

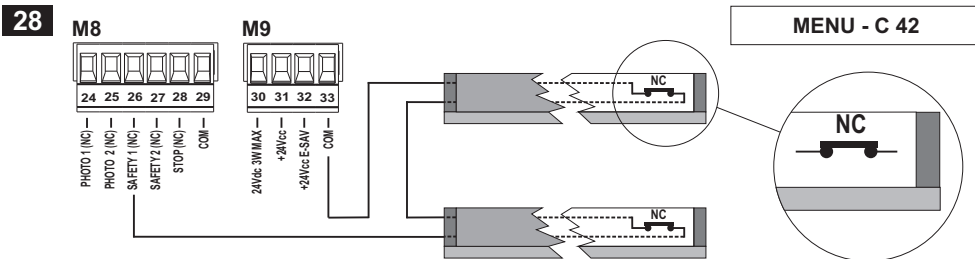

COLLEGAMENTO "DISPOSITIVO DI SICUREZZA 1" 8K2 / 8K2 "SAFETY DEVICE 1" CONNECTION

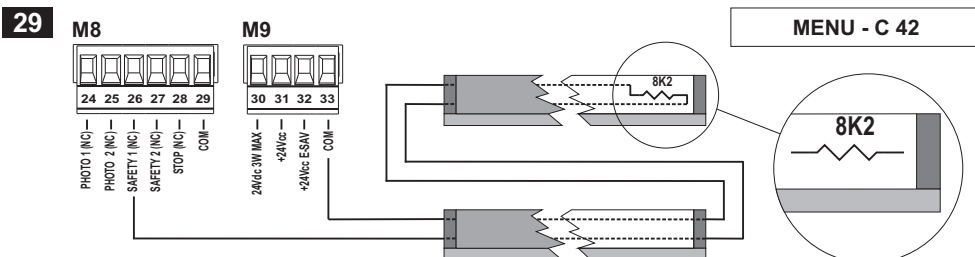

COLLEGAMENTO "DISPOSITIVO DI SICUREZZA 2" NC / NC "SAFETY DEVICE 2" CONNECTION

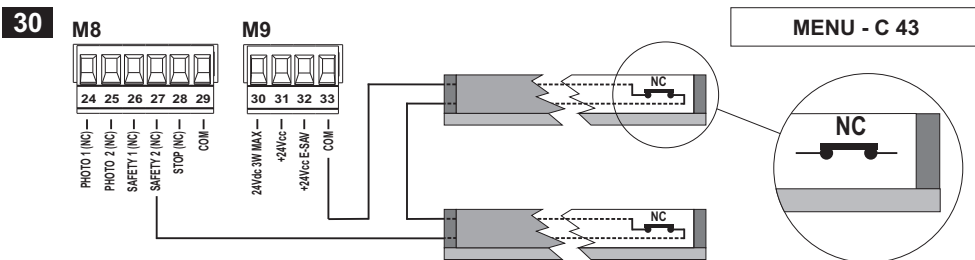

COLLEGAMENTO "DISPOSITIVO DI SICUREZZA 2" 8K2 / 8K2 "SAFETY DEVICE 2" CONNECTION

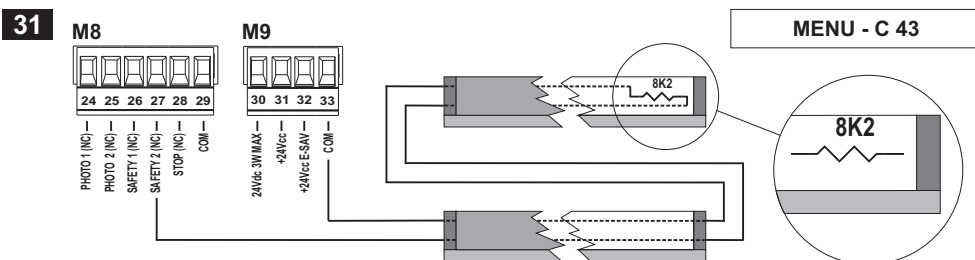

COLLEGAMENTO STOP / STOP CONNECTION

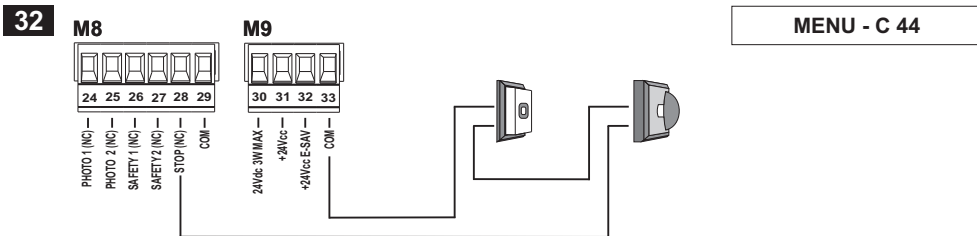

COLLEGAMENTO SPIA DI SEGNALAZIONE / WARNING LIGHT CONNECTION



COLLEGAMENTO SENSORE GIRI MOTORE / MOTOR RPM SENSOR

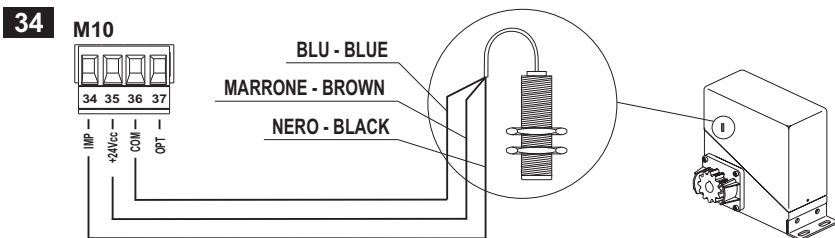

COLLEGAMENTO PER LA SINCRONIZZAZIONE DI DUE CENTRALI / 2 CONTROL BOARDS SYNCHRONIZATION

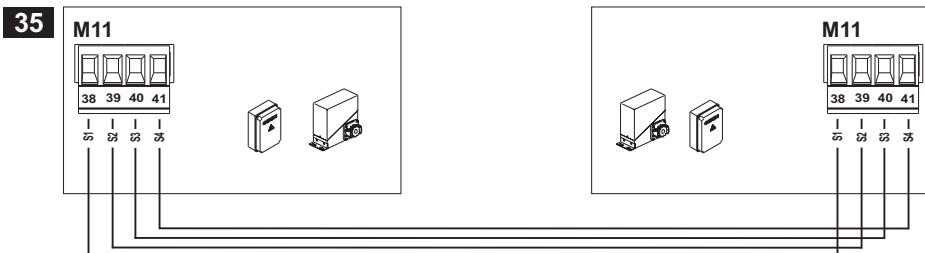

GIBIDI

G.I.B.I.D.I. S.r.l.

Via Abetone Brennero, 177/B
46025 Poggio Rusco (MN) - ITALY
Tel. +39.0386.52.20.11
Fax +39.0386.52.20.31
E-mail: comm@gibidi.com

Numero Verde: 800.290156

www.gibidi.com

